

30L Stainless Steel Digital Combi Microwave



IG3091

Please read these instructions carefully before use and retain for future reference

CONTENTS

Precautions & Specifications.....	3
Safety instructions.....	4-8
Materials information.....	9-10
Countertop installation.....	11
Digital display.....	11
Operation instructions.....	12-18
Troubleshooting.....	19
Igenix Warranty.....	20-21
Product disposal and recycling.....	22

PRECAUTIONS TO AVOID POSSIBLE EXPOSURE TO EXCESSIVE MICROWAVE ENERGY

- (a) Do not attempt to operate this microwave with the door open, this can result in harmful exposure to microwave energy. It is important not to break or tamper with the safety interlocks.
- (b) Do not place any objects between the microwave front face and the door or allow soil or cleaner residue to accumulate on sealing surfaces.
- (c) **WARNING:** If the door or door seals are damaged, the microwave must not be operated until it has been repaired by a qualified engineer.

ADDENDUM

If the apparatus is not maintained in a good state of cleanliness, its surface could be degraded and affect the lifespan of the apparatus and lead to a dangerous situation.

SPECIFICATIONS

Model:	IG309I
Rated Voltage:	230-240V ~ 50Hz
Rated Input Power(Microwave):	1400-1450W
Rated Output Power(Microwave):	850-900W
Grill Input Power:	1000-1100W
Convection Input Power:	2300-2500W
Oven Capacity:	30 L
Turntable Diameter:	315 mm
External Dimensions:	520x497x326mm
Net Weight:	Approx. 19.0 kg

IMPORTANT SAFETY INSTRUCTIONS

Warning: To reduce the risk of fire, electric shock, injury to persons or exposure to excessive microwave energy when using your appliance, follow basic precautions below:

1. **Warning:** Liquids and other foods must not be heated in sealed containers as they are liable to explode.
2. **Warning:** It is hazardous for anyone other than a qualified engineer to carry out any service or repairs that involves the removal of a cover which gives protection against exposure to microwave energy.
3. This appliance can be used by children aged from 8 years and above and persons with reduced physical, sensory or mental capabilities if they have been given supervision or instruction concerning use of the appliance in a safe way and understand the hazards involved.
Cleaning and user maintenance shall not be made by children unless they are older than 8 years and supervised.
4. Keep the appliance and its cord out of reach of children less than 8 years.
5. Only use utensils that are suitable for use in microwaves.
6. The microwave should be cleaned regularly and any food deposits should be removed.
7. Read and follow the specific: "PRECAUTIONS TO AVOID POSSIBLE EXPOSURE TO EXCESSIVE MICROWAVE ENERGY".
8. When heating food in plastic or paper containers, keep an eye on the microwave due to the possibility of ignition.
9. If smoke is emitted, switch off or unplug the appliance and keep the door closed in order to stifle any flames.
10. Do not overcook food.
11. Do not use the microwave cavity for storage purposes. Do not store items, such as bread, cookies, etc. inside the microwave.
12. Remove wire twist-ties and metal handles from paper or plastic containers/bags before placing them in the microwave.
13. Install or locate this microwave only in accordance with the installation instructions provided.

14. Eggs in their shell and whole hard-boiled eggs should not be heated in microwaves since they may explode, even after microwave heating has ended.
15. This appliance is intended to be used in household and similar applications such as:
 - staff kitchen areas in shops, offices and other working environments;
 - by clients in hotels, motels and other residential type environments;
 - farm houses;
 - bed and breakfast type environments.
16. If the supply cord is damaged, it must be replaced by the manufacturer, its service agent or similarly qualified engineer in order to avoid a hazard.
17. Do not store or use this appliance outdoors.
18. Do not use this microwave near water or in a wet basement.
19. The temperature of accessible surfaces may be high when the appliance is operating. The surfaces are liable to get hot during use. Keep cord away from heated surface, and do not cover any vents on the microwave.
20. Do not let the cord hang over edge of the table or counter.
21. Failure to maintain the microwave in a clean condition could lead to deterioration of the surface that could adversely affect the life of the appliance and possibly result in a hazardous situation.
22. The contents of feeding bottles and baby food jars shall be stirred or shaken and the temperature checked before consumption, in order to avoid burns.
23. Microwave heating of beverages can result in delayed eruptive boiling, therefore care must be taken when handling the container.
24. The appliances are not intended to be operated by means of an external timer or separate remote-control system.
25. Appliances can be used by persons with reduced physical, sensory or mental capabilities or lack of experience and knowledge if they have been given supervision or instruction

concerning use of the appliance in a safe way and understand the hazards involved.

26. Children shall not play with the appliance.
27. Accessible parts may become hot during use. Young children should be kept away.
28. A steam cleaner is not to be used on this appliance.
29. During use the appliance becomes hot. Care should be taken to avoid touching heating elements inside the microwave.
30. Only use the temperature probe recommended for this microwave. (For microwaves provided with a facility to use a temperature-sensing probe).
31. The rear surface of the appliance can be placed against a wall.
32. The microwave must not be placed in a cabinet.
33. The microwave is intended for heating food and beverages. Drying of food or clothing and heating of objects e.g. sponges, damp cloths and similar may lead to risk of injury, ignition or fire.

READ CAREFULLY AND KEEP FOR FUTURE REFERENCE

To Reduce the Risk of Injury to Persons

Earthed Installation

DANGER

Electric Shock Hazard: Touching some of the internal components can cause serious personal injury or death. Do not disassemble this appliance.

WARNING

Electric Shock Hazard: Improper use of the earth wire can result in an electric shock. Do not plug into an outlet until appliance is properly installed and earthed. This appliance must be earthed. In the event of an electrical short circuit, earthing reduces the risk of electric shock by providing an escape wire for the electric current. This appliance is equipped with a cord having an earthed wire with a earthed plug. The plug must be plugged into an outlet that is properly installed and earthed.

Consult a qualified electrician or engineer if the earthing instructions are not completely understood or if doubt exists as to whether the appliance is properly earthed. If it is necessary to use an extension cord, use only a 3-wire extension cord.

1. A short power-supply cord is provided to reduce the risk of becoming entangled in or tripping over a longer cord.
2. If a long cord set or extension cord is used:
 - 1) The marked electrical rating of the cord set or extension cord should be at least as great as the electrical rating of the appliance.
 - 2) The extension cord must be earthed with a -type 3-wire cord.
 - 3) The long cord should be arranged so that it will not drape over the counter top or tabletop where it can be pulled on by children or tripped over unintentionally.

CLEANING

Be sure to unplug the appliance from the power supply.

1. Clean the cavity of the microwave after using with a slightly damp cloth.
2. Clean the accessories in the usual way in soapy water.
3. The door frame and seal and neighbouring parts must be cleaned carefully with a damp cloth when they are dirty.
4. Do not use harsh abrasive cleaners or sharp metal scrapers to clean the microwave door glass since they can scratch the surface, which may result in shattering of the glass.
5. Cleaning Tip---For easier cleaning of the cavity walls that the food cooked can touch: Place half a lemon in a bowl, add 300ml (1/2 pint) water and heat on 100% microwave power for 10 minutes. Wipe the microwave clean using a soft, dry cloth.

UTENSILS CAUTION

Personal Injury Hazard: It is hazardous for anyone other than a qualified engineer to carry out any service or repair operation that involves the removal of a cover which gives protection against exposure to microwave energy.

See the instructions on “Materials you can use in a microwave or to be avoided in a microwave.” There may be certain non-metallic utensils that are not safe to use for microwaving. If in doubt, you can test the utensil in question following the procedure below.

Utensil Test:

1. Fill a microwave-safe container with 1 cup of cold water (250ml) along with the utensil in question.
2. Cook on maximum power for 1 minute.
3. Carefully feel the utensil. If the utensil is warm, do not use it for microwave cooking.
4. Do not exceed 1 minute cooking time.

MATERIALS YOU CAN USE IN A MICROWAVE

Utensils	Remarks
Aluminum foil	Shielding only. Small smooth pieces can be used to cover thin parts of meat or poultry to prevent overcooking. Arcing can occur if foil is too close to microwave walls. The foil should be at least 1 inch (2.5cm) away from microwave walls.
Browning dish	Follow manufacturer's instructions. The bottom of browning dish must be at least 3/16 inch (5mm) above the turntable. Incorrect usage may cause the turntable to break.
Dinnerware	Microwave-safe only. Follow manufacturer's instructions. Do not use cracked or chipped dishes
Glass jars	Always remove lid. Use only to heat food until just warm. Most glass jars are not heat resistant and may break
Glassware	Heat-resistant microwave glassware only. Make sure there is no metallic trim. Do not use cracked or chipped dishes.
Microwave cooking bags	Follow manufacturer's instructions. Do not close with metal tie. Make slits to allow steam to escape.
Paper plates and cups	Use to cover food for reheating and absorbing fat. Use with supervision for a short-term cooking only. Do not leave microwave unattended while cooking
Paper towels	Use to cover food for re-heating and absorbing fat. Use for short-term cooking/warming only.
Parchment paper.	Use as a cover to prevent splattering or a wrap for steaming.
Plastic	Microwave-safe only. Follow the manufacturer's instructions. Should be labeled "Microwave Safe". Some plastic containers soften, as the food inside gets hot. "Boiling bags" and tightly closed plastic bags should be slit, pierced or vented as directed by package.
Plastic wrap	Microwave-safe only. Use to cover food during cooking to retain moisture. Do not allow plastic wrap to touch food.
Thermometers	Microwave-safe only (meat and candy thermometers).
Wax paper	Use as a cover to prevent splattering and retain moisture

MATERIALS TO BE AVOIDED IN A MICROWAVE

Utensils	Remarks
Aluminum tray	May cause arcing. Transfer food into microwave-safe dish.
Food carton with metal handle	May cause arcing. Transfer food into microwave-safe dish.
Metal or metal-trimmed utensils	Metal shields the food from microwave energy. Metal trim may cause arcing.
Metal twist ties	May cause arcing and could cause a fire in the microwave.
Paper bags	May cause a fire in the microwave.
Plastic foam	Plastic foam may melt or contaminate the liquid inside when exposed to high temperature.
Wood	Wood will dry out when used in the microwave and may split or crack.

SETTING UP YOUR MICROWAVE

Names of Microwave Parts and Accessories

Remove the microwave and all materials from the carton and microwave cavity. Your microwave comes with the following accessories:

- Glass tray
- Turntable ring assembly
- Instruction Manual

- A) Control panel
- B) Turntable shaft
- C) Turntable ring assembly
- D) Glass tray
- E) Observation window
- F) Door assembly
- G) Safety interlock system

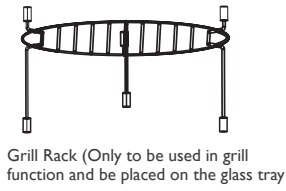
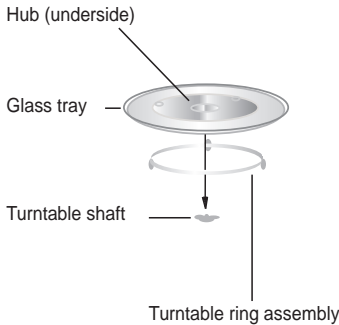
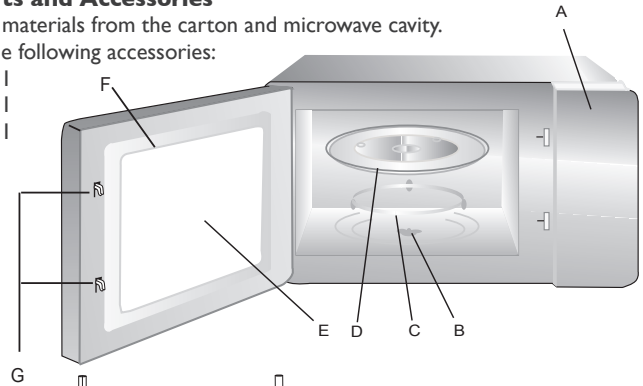

- a. Never place the glass tray upside down. The glass tray should never be restricted.
- b. Both glass tray and turntable ring assembly must always be used during cooking.
- c. All food and containers of food are always placed on the glass tray for cooking.
- d. If glass tray or turntable ring assembly cracks or breaks, contact our Igenix sales team

COUNTERTOP INSTALLATION

Remove all packing material and accessories. Examine the microwave for any damage such as dents or a broken door. Do not install if microwave is damaged.

Cabinet: Remove any protective film found on the microwave cabinet surface.

Do not remove the light brown Mica cover that is attached to the microwave cavity to protect the magnetron.

INSTALLATION

1. Select a level surface that provides enough open space for the intake and/or outlet vents.

- (1) The minimum installation height is 85cm.
- (2) The rear surface of the appliance should be placed against a wall. Leave a minimum clearance of 30cm above the microwave, a minimum clearance of 20cm is required between the microwave and any adjacent walls.
- (3) Do not remove the legs from the bottom of the microwave.
- (4) Blocking the intake and/or outlet openings can damage the microwave.
- (5) Place the microwave as far away from radios and TV as possible. Operation of the microwave may cause interference to your radio or TV reception.

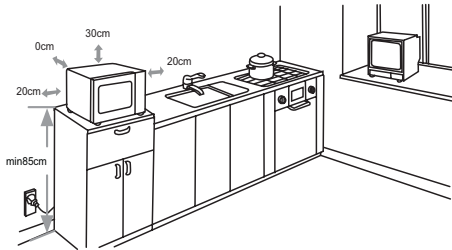

2. Plug your microwave into a standard household outlet. Be sure the voltage and the frequency is the same as the voltage and the frequency on the rating label.

WARNING: Do not install microwave over a range cooktop or other heat-producing appliances. If installed near or over a heat source, the microwave could be damaged and the warranty would be void.



The accessible surface may be hot during operation.

DIGITAL DISPLAY



- Indicates microwave cooking is taking place
- Indicates grill cooking is taking place
- Indicates convection cooking is taking place
- Indicates microwave and grill combi cooking is taking place
- Indicates microwave and convection combi cooking is taking place
- Indicates grill and grill convection cooking is taking place
- Indicates microwave, grill and convection combi cooking is taking place
- Indicates defrosting is taking place
- Indicates the auto menu function has been selected
- Indicates the safety lock is engaged
- g** Indicates the weight is being set
- °C** Indicates the temperature



OPERATION INSTRUCTIONS

I. Clock Setting

When the microwave oven is turned on, the oven will display “00:00”, and the Buzzer will ring once.

- 1) Press “**Clock/Kitchen Timer**” once. “00:00” displays.
- 2) Turn “” to adjust the hour figures, the input time should be within 0--23(24-hour).
- 3) Press “**Clock/Kitchen Timer**”, the minute figures will flash.
- 4) Turn “” to adjust the minute figures, the input time should be within 0--59.
- 5) Press “**Clock/Kitchen Timer**” to finish clock setting. “:” will flash.

Note: 1) If the clock is not set, it would not function when powered.

- 2) During the process of clock setting, if you press “**Stop/Clear**”, the oven will go back to the previous status automatically.

2. Kitchen Timer

- 1) Press “**Clock/Kitchen Timer**” twice, LED will display 00:00.
- 2) Turn “” to enter the correct timer. (The maximum cooking time is 95 minutes.)
- 3) Press “**Start/+30Sec./Confirm**” to confirm setting.
- 4) When the kitchen time is reached, the buzzer will ring 5 times.

If the clock has been set to the (24-hour system), LED will display the current time.

Note: The kitchen time is the clock & will display the current time. The kitchen timer is set to cook food for the period of time you chose.

3. Microwave Cooking

Press “**Microwave**” the LED will display “P100”. Press “**Microwave**” four times to choose the power you want, and “P100”, “P 80”, “P 50”, “P 30” or “P 10” will display for each added press. Then press “**Start/+30Sec./Confirm**” to confirm, and turn “” to adjust the cooking time.. (The maximum cooking time is 95 minutes.). Press “**Start/+30Sec./Confirm**” again to start cooking.

Example: If you want to use 80% microwave power to cook for 20 minutes, you can operate the oven with the following steps.



- 1) Press “**Microwave**” once, the screen displays “P100”.
- 2) Press “**Microwave**” once again to choose 80% microwave power.
- 3) Press “**Start/+30Sec./Confirm**” to confirm, and the screen displays “P 80”.
- 4) Turn “” to adjust the cooking time until the oven displays “20:00”.
- 5) Press “**Start/+30Sec./Confirm**” to start cooking .

Note: The step quantities for the adjustment time of the coding switch are as follow:

- 0---1 min : 5 seconds
- 1---5 min : 10 seconds
- 5---10 min : 30 seconds
- 10---30 min : 1 minute
- 30---95 min : 5 minutes

Press	Once	Twice	Thrice	4 times	5 times
Microwave Power	100%	80%	50%	30%	10%

4. Grill or Combi. Cooking

Press “**Grill/Combi.**” the LED will display “G-1”, and press “**Grill/Combi.**” for times or turn “” to choose the power you want, and “G”, “C-1”, “C-2”, “C-3” or “C-4” will display for each added press. Then press “**Start/+30Sec./Confirm**” to confirm, and turn “” to adjust the cooking time. (The maximum setting time is 95 minutes.) Press “**Start/+30Sec./Confirm**” again to start cooking.

Example: If you want to use grill power to cook for 10 minutes, you can operate the oven as the following steps.

- 1) Press “**Grill/Combi.**” once, the screen displays “G-1”.
- 2) Press “**Start/+30Sec./Confirm**” to confirm.
- 3) Turn “” to adjust the cooking time until the oven displays “10:00”.
- 4) Press “**Start/+30Sec./Confirm**” to start cooking.



Note: If half the grill time passes, the oven sounds twice, and this is normal. In order to have a better effect of grilling food, you should turn the food over, close the door, and press “**Start/+30Sec./Confirm**” to continue cooking. If no interruptions the oven will continue cooking.

Note: Combination instructions



Instructions	Display	Microwave	Grill	Convection
1	C-1	●		●
2	C-2	●	●	
3	C-3		●	●
4	C-4	●	●	●

5. Convection Cooking (With pre-heat function)

With convection cooking you can cook the food as you would in a traditional oven. It is recommended that you should pre-heat the oven to the appropriate temperature before placing the food in the oven.

- 1) Press the “**Convection**” key once, “140” flashes.
- 2) Keep pressing “**Convection**” or turn “” to select the convection function.
Note: The temperature can be chosen from 140 degrees to 230 degrees.
- 3) Press the “**Start/+30Sec./Confirm**” to confirm the temperature.
- 4) Press the “**Start/+30Sec./Confirm**” to start pre-heating. When the preheating temperature arrives, the buzzer will sound twice to remind you to put the food into the oven. The pre-heated temperature is displayed and flashes.
- 5) Put the food into the oven and close the door. Turn “” to adjust the cooking time. (The maximum setting time is 95 minutes.)
- 6) Press the “**Start/+30Sec./Confirm**” key to start cooking.
Note: a) Cooking time cannot be input until the pre-heating temperature arrives. If the temperature arrives, door must be opened to input the cooking time.
b) If the time is not input within 5 minutes, the oven will stop pre-heating. The buzzer sounds five times and turns back to waiting state.

6. Convection Cooking (Without pre-heating function)



- 1) Press the “**Convection**” key once, “140” flash.
- 2) Keep pressing “**Convection**” or turn “” to select the convection function.
Note: The temperature can be chosen from 140 degrees to 230 degrees.
- 3) Press the “**Start/+30Sec./Confirm**” to confirm the temperature.
- 4) Turn “” to adjust the cooking time. (The maximum setting time is 95 minutes.)
- 5) Press the “**Start/+30Sec./Confirm**” key to start cooking.

7. Multi-Stage Cooking

Two stages can be set at one time. If one stage is defrosting, it should be put in as the first stage. The buzzer will ring once after each stage and the next stage will begin.

Note: Auto menu and pre-heating cannot be set as one of the multi-stages.

Example: If you want to defrost the food for 5 minutes, then to cook with 80% microwave power for 7 minutes. The steps are as following:

- 1) Press “**W.T./Time Defrost**” twice, the screen will display “d-2”;
- 2) Turn “” to adjust the defrost time of 5 minutes;
- 3) Press “**Microwave**” once, “P100” will display;
- 4) Press “**Microwave**” again to choose 80% microwave power till “P 80” displays;
- 5) Press “**Start/+30Sec./Confirm**” to confirm;
- 6) Turn “” to adjust the cooking time of 7 minutes;
- 7) Press “**Start/+30Sec./Confirm**” to start cooking.

8. Speedy Cooking



- 1) In waiting state, press “**Start/+30Sec./Confirm**” key to cook with 100% power level for 30 seconds. Each time you press on the same key it will increase by 30 seconds. The maximum cooking time is 95 minutes.
- 2) During microwave, grill, convection and combination states, cooking time can be increased by pressing “**Start/+30Sec./Confirm**”. Each time you press it will increase by 30 seconds.

Note: This function cannot work under defrost, multi-stage and auto menu cooking.

AUTO MENU

Menu	Weight (g)	Display	Power
A-1 Pizza	200	200	C-4
	300	300	
	400	400	
A2 Potato	1 (about 230g)	1	100%
	2 (about 460g)	2	
	3 (about 690g)	3	
A3 Meat	150	150	100%
	300	300	
	450	450	
	600	600	
A4 Fish	150	150	80%
	250	250	
	350	350	
	450	450	
	650	650	
A5 Vegetable	150	150	100%
	350	350	
	500	500	
A6 Beverage /Coffee	1 cup (about 240g)	1	100%
	2 cups (about 480g)	2	
	3 cups (about 720g)	3	
A7 Pasta	50(with water 450ml)	50	80%
	100(with water 800ml)	100	
	150(with water 1200ml)	150	
A8 Popcorn	50	50	100%
	100	100	
A9 Cake	475	475	Preheat at 160°C
A10 Chicken	500	500	C-4
	750	750	
	1000	1000	
	1200	1200	

9. Auto Menu

- 1) In waiting state, turn “” right to choose the function wanted, and “A1”, “A2”, “A3”....”A10” will be displayed.
- 2) Press “**Start/+30Sec./Confirm**” to confirm the menu you need.
- 3) Turn “” to choose the weight menu, and “g” indicator will light.
- 4) Press “**Start/+30Sec./Confirm**” to start cooking.

Note: When you choose A9 cake, please do not put the cake into the oven at the beginning. The oven needs to be pre-heated to 160 degree first. After several minutes, the buzzer sounds twice to remind you to put the cake into the oven. After putting the cake in the oven, please press start again. The timer will count down, and the cake will be cooked perfectly.

10. Defrost by Weight

- 1) Press “**W.T./Time Defrost**” pad once, the oven will display “d-1”.
- 2) Turn “” to select the weight of food. At the same time, “g” will light. The weight should be within 100-2000g.
- 3) Press “**Start/+30Sec./Confirm**” key to start defrosting.

11. Defrost by Time

- 1) Press “**W.T./Time Defrost**” key twice, the oven will display “d-2”.
- 2) Turn “” to select the cooking time. The maximum setting time is 95 minutes.
- 3) Press “**Start/+30Sec./Confirm**” key to start defrosting.

12. Inquiring Function

- 1) During cooking state, press “**Clock/Kitchen Timer**” to check the current time. It will be displayed for 2-3 seconds.
- 2) In cooking state, press “**Microwave**”, “**Grill/Combi.**” or “**Convection**”, the current power will be displayed for 2-3 seconds.

13. Child Lock

Lock: In waiting state, press “Stop/Clear” for 3 seconds, there will be a long “beep” denoting entering into the children-lock state and “” indicator will light. LED will display current time or 0:00.

Unlock: In locked state, press “Stop/Clear” for 3 seconds, there will be a long “beep” denoting that the lock is released, and “” indicator will disappear.

14. Additional Information

- 1) The buzzer will sound once when turning the knob at the beginning.
- 2) “Start/+30Sec./Confirm” must be pressed to continue cooking if the door is opened during cooking.
- 3) Once the cooking programmer has been set, “Start/+30Sec./Confirm” is not pressed in 5 minutes. The current time will be displayed. The setting will be cancelled.
- 4) The buzzer sounds once by pressing down firmly, inefficient pressing will have no response.
- 5) The buzzer will sound five times to remind you when cooking is finished.

TROUBLESHOOTING

Normal	
Microwave oven interfering with TV reception	Radio and TV reception may be interfered when the microwave is operating. It is similar to the interface of smaller electrical appliances, like mixer, vacuum cleaner, and electric fan. It is normal
Dim oven light	In low power microwave cooking, oven light may become dim. It is normal.
Steam accumulating on door, hot air out of vents	In cooking, steam may come out of food. Most will get out through the vents. But some may accumulate on cool places like microwave door. It is normal
Oven started accidentally with no food in.	You must not run the unit without any food inside. It is very dangerous.

Trouble	Possible Cause	Remedy
Oven can not be started	1. Power cord is not plugged in tightly.	Unplug. Then plug in again after 10 seconds
	2. Fuse blowing or circuit breaker works	Replace fuse or reset circuit breaker (repaired by qualified engineer)
	3. Trouble with outlet	Test outlet with other electrical appliances
Microwave does not heat	4. Door not closed well	Close door fully
Glass turntable makes noise when microwave oven operates	5. Dirty roller rest and microwave bottom	Refer to "Maintenance of Microwave" to clean dirty parts



According to Waste of Electrical and Electronic Equipment (WEEE) directive, WEEE should be separately collected and treated. If at any time in future you need to dispose of this product please do NOT dispose of this product with household waste. Please send this product to WEEE collecting points where available.



Thank you for choosing Igenix...

As a valued customer we would like to offer you a **FREE** 2 year warranty to cover your product against any electrical or mechanical defects.

This means that in the unlikely event you develop a fault or problem with your product we will happily repair or replace the item free of charge.

To qualify for the 2 year warranty you must register your product within **30 days of purchase**. The full Terms & Conditions of our warranty policy are on the reverse of this form. They are also available on our website. www.igenix.co.uk

To register your product, please complete all sections of the form below and return to us at the following address. Igenix, Pik-a-Pak Electrical Distributors, 38 Bluestem Road, Ransomes Europark, Ipswich, IP3 9RR.

Alternatively you visit the Igenix website and complete the form online.

Personal Details

Title _____ **First Name** _____ **Surname** _____

Address _____

Post Code _____

Email _____ **Telephone** _____

Product Information

Product Code _____ **Product Description** _____
(Beginning IG)

Batch Number _____ **Serial Number** _____
(Beginning 5) (If Applicable)

Purchase Date _____ **Retailer Name** _____

Retailer Location _____

Please tick here to confirm you have read and accept our Terms & Conditions on reverse

Please tick here if you **do not** wish to receive marketing information from us

Igenix Warranty Terms & Conditions

This product is guaranteed for a period of 12 months as standard from the date of purchase against mechanical and electrical defects. You can extend your warranty for a further 12 months by registering your product.

Upon registration we will cover your product for a period of 24 months from the original purchase date against any mechanical or electrical defects.

To qualify for the guarantee the product must be used for domestic household use only and in accordance with the instructions in the user manual. Any misuse of the product will result in the warranty being void.

The guarantee does not cover accidental damage, misuse, neglect, tampering or incorrect adjustment or installation.

The guarantee will be rendered invalid if the product is resold, has had its serial number removed (or has an invalid serial number), or if an unauthorised person has carried out any repairs or alterations.

The warranty does not cover accessories or consumable parts that require replacement under normal use. This includes shelving, dials, filters, belts and trays etc.

In the unlikely event of a breakdown please refer to the Troubleshooting guide in your user manual and check all plugs, fuses and electricity supply.

If you still require assistance please contact our Customer Service department on 01473 271 272 or write to us at the following address:

Customer Service Department

Pik-a-Pak Electrical Distributors
38 Bluestem Road
Ransomes Europark
Ipswich
IP3 9RR

Please quote the Product Code which begins 'IG' and the Batch Number beginning '5' and give details of the exact fault. We will then decide whether to repair or replace the item.

Before we arrange the repair or replacement you will be required to return a copy of your proof of purchase. **Please retain your original.**

If an item is replaced within the agreed guarantee period, the guarantee for the replacement item will be calculated from the purchase date of the original.

In the event that the product is inspected and no fault is found or the product is not within the guarantee period you will be charged for the repair and any carriage costs.

Please Note: As a warranty policy we cannot refund the consumers purchase price.

IMPORTANT

THERE ARE NO USER SERVICEABLE PARTS INSIDE AND THE CASING SHOULD NOT BE OPENED BY AN UNQUALIFIED PERSON

THIS APPLIANCE IS INTENDED FOR DOMESTIC USE ONLY

2
YEAR GUARANTEE

This product carries a 2 year guarantee. If you experience any problems with your Igenix product please call our Customer Services Department on 01473 271 272.

DISPOSAL INFORMATION



The European Directive 2012/19/EU on Waste Electrical and Electronic Equipment (WEEE), requires that old household electrical appliances must not be disposed of in normal unsorted municipal waste.

Old appliances must be collected separately in order to optimise the recovery and recycling of the materials they contain and reduce the impact on human health and the environment.

The crossed out “wheeled bin” symbol on the product reminds you of your obligation, that when you dispose of the appliance it must be separately collected. Consumers should contact their local authority or retailer for information concerning the correct disposal of their old appliance.

IGENIX

Distributed by Pik-a-Pak Electrical Distributors
38 Bluestem Road, Ransomes Europark, Ipswich, IP3 9RR
Tel. 01473 271 272